

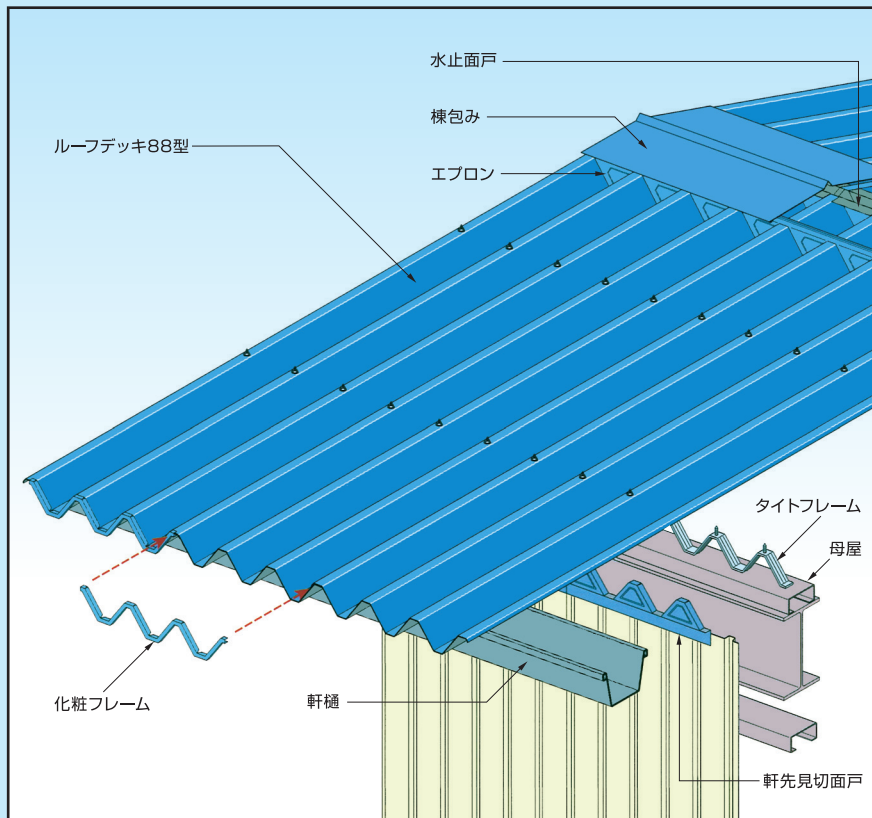













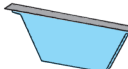
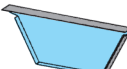
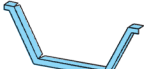



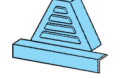



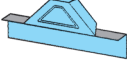

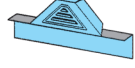
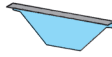
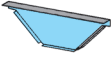
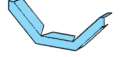

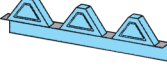

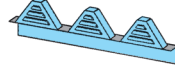
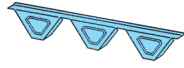



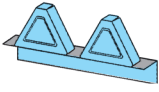

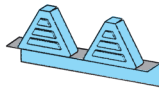
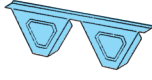
	名称	タイトフレーム	ケラバフレーム※	吊子※	ボルト・ナット
はぜ締め形折板屋根	ハゼ式折板 V-500型 2.6t×45W 3.2t×45W(耐火仕様)				ナット
	ハゼ式折板 V-333型 2.6t×45W 3.2t×45W(耐火仕様)				六角ボルト
	ハゼ式折板 OW-650型 2.3t×40W		吊子なし		インサート
重ね形折板屋根	重ね形折板 ルーデッキ88型 2.3t×30W 3.2t×30W(耐火仕様)	3点セット 	ワンサイド ボルト R8 R6	ナット付 インサート R8B	ランドマン ボルト
	重ね形折板 中型折板 W-150型 3.0t×38W 3.2t×38W(耐火仕様)	3点セット 	吊工法用座付ボルト 5/16×30 3/8×40	アタックボルト 母屋7~11mm用	
	重ね形折板 大型折板 V-173型 3.2t×45W(耐火仕様)	3点セット 			

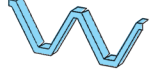
※吊子、ケラバフレームの吊子はオプションにて補強可能です。

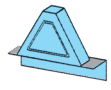

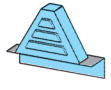

■構成図

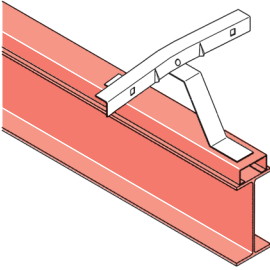
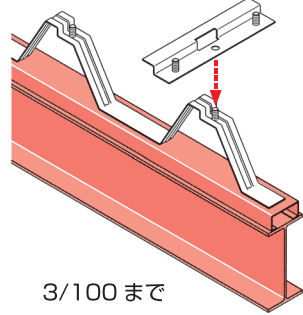
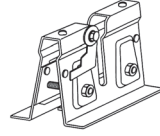
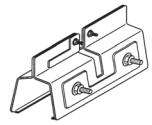

【単位：mm】

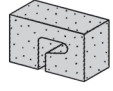
	軒先面戸	軒先見切面戸	換気面戸	換気見切面戸	エブロン	水止面戸	化粧フレーム
	 ※耐風面戸も あります。 (オプション)						
							
							
							
							
							

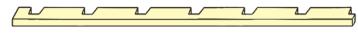
はげ締め形折板用 棟タイトフレーム	折板用雪止金具
<ul style="list-style-type: none"> ●タイトフレーム 1山用 ●タイトフレーム 2連用   <p>3/100 まで</p>	<ul style="list-style-type: none"> ●はげ締め形折板用 ●かんこう形折板用 (OK ルーフ 66 型用)  

棟止金具	ケミカル棟面戸	ケミカル面戸	
	<ul style="list-style-type: none"> ●はげ式折板用 ●OW-650 中間用  	大波用 	小波用 
		長尺角波用 	
		OS サイディング用 	
		OK サイディング用 